

**FP-MLAPB**  
**FULL-MOTION WALL MOUNT**  
 FOR LCD, PLASMA, and LED DISPLAYS

**INSTRUCTION MANUAL**  
**SPECIFICATIONS**

**Display Size:** 27" to 42"  
**Maximum Load:** 25 kg (55 lbs)  
**Mounting Pattern:** 400 mm x 400 mm (15.7" x 15.7") max  
**Tilt Range:** up to 10° down  
**Rotates:** ± 45°  
**Profile:** 1.6" to 16.4"

**BOX CONTENTS**

- Mount (x1)
- Mount Arm (x2)
- Instruction Manual (x1)
- Hardware Kit (x1)

**WARNINGS**

- 1 **Read these instructions before you begin.** If you are unsure of any part of the process, contact a professional contractor or installer for assistance. Improper installation can result in injury or damage.
- 2 The wall or mounting surface must be capable of supporting the combined weight of the mount and the display; if not, the structure must be reinforced.
- 3 Locate pipes, wires, or any other hazards in the wall where you wish to install the mount before drilling.
- 4 Safety gear and proper tools must be used. Failure to do so can result in injury or damage.
- 5 A minimum of two people are required for installation. Do not attempt to install this mount alone under any circumstances.
- 6 Follow all instructions and recommendations regarding adequate ventilation and suitable locations for mounting your display. Consult the owner's manual for your particular display for more information.











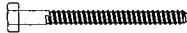

**WARNINGS (continued)**

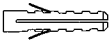
**CAUTION:** This wall mount is intended for use only with the maximum weight of 25 kg (55 lbs). Use with heavier than the maximum weights indicated may result in instability causing possible injury.

**TOOLS REQUIRED**

- Phillips Head Screw Driver
- Ratchet or Driver with 13 mm (1/2") Socket
- Electric or Portable Drill
- 6 mm (1/4") Drill Bit and Stud Finder for Drywall Installation
- 10 mm (3/8") Masonry Bit for Concrete Installation
- Level

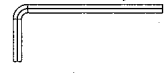
**HARDWARE KIT**

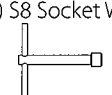
- |   |   |
|---|---|
| (A) M8 x 63 Lag Bolt (x2)   | (H) M8 x 12 Screw (x4)  |
|    |    |
| (B) Lag Bolt Washer (x2)  | (I) M8 x 30 Screw (x4)  |
|    |    |
| (C) Concrete Anchor (x2)  | (J) M6 Washer (x4)  |
|    |    |
| (D) M4 x 12 Screw (x4)  | (K) M8 Washer (x4)  |
|   |   |
| (E) M4 x 20 Screw (x4)  | (L) Spacer (x8)   |
|  |  |
| (F) M6 x 12 Screw (x4)  | (M) S4 Allen Key (x1)   |
|  |  |
| (G) M6 x 30 Screw (x4)  | (N) S8 Socket Wrench (x1)   |
|  |  |

**INSTALLATION**

**Part 1A – Mounting to the Wall (Drywall)**

**IMPORTANT!** For safety reasons, this mount must be secured to a wood stud capable of supporting the combined weight of the mount and display. Do not mount to drywall alone.

**Part 1A – Mounting to the Wall (Drywall) (continued)**

- 1 Use a high quality stud finder to locate a stud where you wish to install your mount. Mark both edges of the stud to help identify the exact center.
- NOTE:** You must use the center of the stud to avoid cracking or splitting the wood during installation.
- 2 Carefully remove the plastic covers from the mount as shown (see Fig. 1).
  - 3 Place the mount against the wall and level it using the integrated bubble level.
  - 4 While another person holds the mount in position, mark two locations for securing the mount to the wall (see Fig. 2).
  - 5 Set the mount aside and drill a 6 mm (1/4") pilot hole at each marked location.
  - 6 Place the mount against the wall over the drilled holes, making sure the arrow on the mount points up. Attach the mount to the wall using the lag bolts (A) and lag bolt washers (B) provided (see Fig. 3). **Do not over-tighten these bolts and do not release the mount until all bolts are in place.** Ensure that the mount remains level after all bolts are secured.

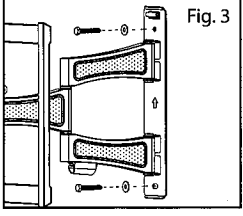
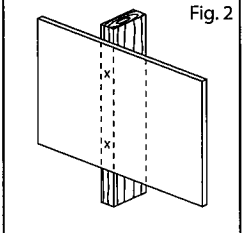
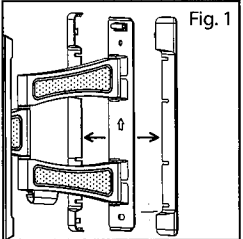

**Part 1B – Mounting to the Wall (Concrete)**

**IMPORTANT!** For safety reasons, the concrete wall must be capable of supporting the combined weight of the mount and the display. The manufacturer takes no responsibility for failure caused by walls of insufficient strength.

- 1 Carefully remove the plastic covers from the mount as shown (see Fig. 1).
- 2 Place the mount against the wall in the desired location and level it using the integrated bubble level.
- 3 While another person holds the mount in place, mark two locations as shown for securing the mount to the wall (see Fig. 4).

## Part 1B – Mounting to the Wall (Concrete) (continued)

- 4 Set the mount aside and drill a 10 mm (3/8") hole at each marked location. Remove any excess dust from the holes.
- 5 Insert a concrete anchor (C) into each hole so that it is flush with the concrete surface (see Fig. 5). A hammer can be used to lightly tap the anchors into place if necessary.  
**NOTE:** If the concrete wall is covered by a layer of plaster or drywall, the concrete anchor must pass completely through the layer to rest flush with the concrete surface.
- 6 Place the mount against the wall over the drilled holes, making sure the arrow on the mount points up. Attach the mount to the wall using the lag bolts (A) and lag bolt washers (B) provided (see Fig. 3). **Do not over-tighten these bolts and do not release the mount until all bolts are in place.** Ensure that the mount remains level after all bolts are secured.

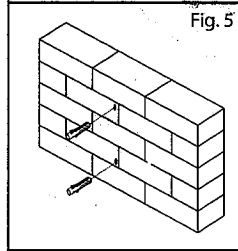
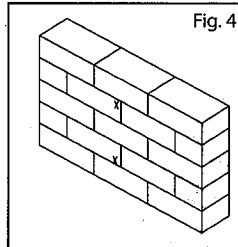

## Part 2 – Attaching the Mount Arms to the Display (continued)

- 2 Determine the correct diameter of screw to use by carefully trying one of each size (M4, M6 and M8) from the hardware kit. **Do not force any of the screws – if you feel resistance stop immediately and try a smaller diameter screw.**
- 3 Attach the mount arms to the back of your display using the screws identified in steps 1 and 2 (see Fig. 6):
  - A If you are using the M4 or M6 screws you will need to use the M6 washers (J). If you are using the M8 screws you will need to use the M8 Washers (K).
  - B If you are using the longer screws on a display with a curved or recessed back, you may also need to use the spacers (L). Use one spacer or two spacers stacked as needed. **Only use a spacer if necessary.**

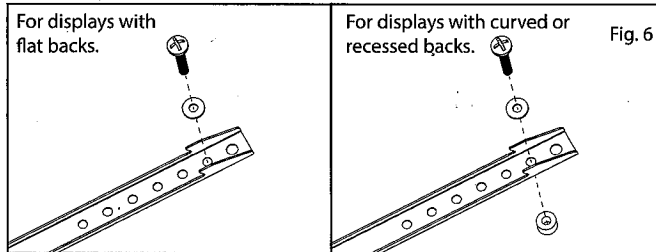

## Part 3 – Final Assembly

- 1 With the help of another person, carefully lift your display and place it on the mount. **Do not release the display until the mount arms have securely hooked onto the mount.**
- 2 Close the safety latch at the bottom of each arm to prevent the display from being lifted from the mount. Each latch will automatically lock when fully closed (see Fig. 7).

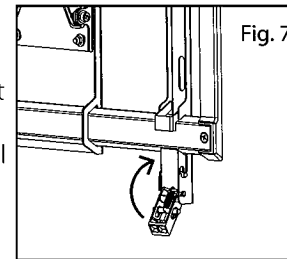

**IMPORTANT!** The latches must be closed and locked at all times to prevent the display from being accidentally knocked from the mount.

- 3 Re-attach the plastic covers that we removed in part 1.
- 4 Cables can be routed through the channel located on the bottom of the mount to keep them organized and out of the way.

## OPERATION AND ADJUSTMENT

- 1 To change the tilt angle of your display, have one person hold the display firmly in place while another person loosens the tilt screws using the S4 Allen key (M) from the hardware kit (see Fig. 8). Once loosened, move your display to the desired position and then re-tighten the screws to lock the angle in place. **Do not release the display until both tilt screws are fully tightened and never remove the tilt screws.**

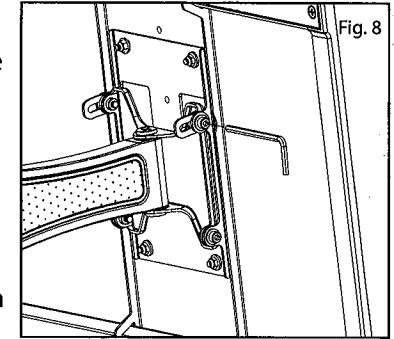

- 2 Swivel adjustments can be made by grasping the display firmly and moving it to the desired position. Be careful that fingers or cables do not get pinched when moving the mount.

- 3 Level correction adjustments can be made by simply rotating the display in the needed direction. If it is too difficult to move the display or if the display does not stay in position once moved, adjust the tension of the four nuts located behind the face plate using the S8 socket wrench (N) provided in the hardware kit (see Fig. 9). Adjust all four nuts evenly. **Do not fully loosen or remove these nuts.**

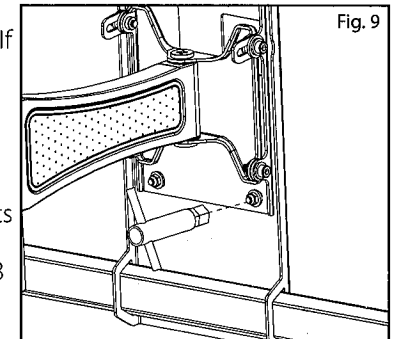

- 4 Periodically clean your mount with a dry cloth. Inspect all screws and hardware at regular intervals to ensure that no connections have become loose over time. Re-tighten as needed.

## Part 2 – Attaching the Mount Arms to the Display

**IMPORTANT!** Use extra care during this part of the installation. If possible, avoid placing your display facedown as it may damage the viewing surface.

**NOTE:** This mount comes with a selection of different screw diameters and lengths to accommodate a wide variety of display models. Not all of the hardware in the kit will be used. If you cannot find the appropriate screw size in the kit provided, consult the manufacturer of your display for more information.

- 1 Determine the correct length of screw to use by examining the back of your display:
  - A If the back of your display is flat and the mounting holes are flush with the surface, you will use the shorter screws (D, F or H) from the hardware kit.
  - B If the back of your display is curved, has a protrusion, or if the mounting holes are recessed, you will need to use the longer screws (E, G or I) and may also need to use the spacers (L).

**VMP**  
VIDEO MOUNT PRODUCTS

Phone number: 877-281-2169  
3202502-140925